

Network Video Recorder

NVR302 Series



Key Features

- Support TVI,AHD, CVI,CVBS, IP cameras with adaptive access
- 8/16-channel BNC input
- Up to 8MP resolution for recording
- Support 1-ch HDMI output at up to 4K, 1-ch VGA output at up to 1920*1080
- Long transmission distance over coax cable

Specifications

Model	NVR302-08Q	NVR302-08U	NVR302-16Q
Video/Audio Input			
Analog Video Input	8-ch, BNC	8-ch, BNC	16-ch, BNC
IP Video Input	4-ch(only IP up to 12ch), each channel up to 4K	8-ch(only IP up to 16ch), each channel up to 4K	8-ch(only IP up to 24ch), each channel up to 4K
Supported Analog Camera Types	Support AHD input: 8MP@15fps (channel1-channel2) 5MP@20fps 4MP@30fps 3MP@30fps(channel1 - channel2) 1080P@30fps 720P@60fps Support TVI input: 8MP@15fps(channel1-channel2) 5MP@20fps 4MP@30fps 3MP@20fps (channel1 - channel2) 1080P@30fps 720P@60fps Support CVI input:	Support AHD input: 8MP@15fps 5MP@20fps 4MP@30fps 3MP@30fps 1080P@30fps 720P@60fps Support TVI input: 8MP@15fps 5MP@20ps 4MP@30fps 3MP@20fps 1080P@30fps 720P@60fps Support CVI input:	Support AHD input: 8MP@15fps(channel1-channel4) 5MP@20fps 4MP@30fps 3MP@30fps (channel1 -channel4) 1080P@30fps 720P@60fps Support TVI input: 8MP@15fps(channel1-channel4) 5MP@20fps 4MP@30fps 3MP@20fps (channel1 - channel4) 1080P@30fps

	8MP@15fps(channel1-channel2) 4MP@30fps 1080P@30fps 720P@60fps Support CVBS input	8MP@15fps 4MP@30fps 1080P@30fps 720P@60fps Support CVBS input	720P@60fps Support CVI input: 8MP@15fps(channel1-channel4) 4MP@30fps 1080P@30fps 720P@60fps Support CVBS input
Audio Input	1-ch, RCA	4-ch, RCA	1-ch, RCA
Two-way Audio	1-ch, RCA	1-ch, RCA	1-ch, RCA
Channel Associated Audio	1-ch, RCA	4-ch, RCA	1-ch, RCA
Network			
Incoming Bandwidth	56Mbps	80Mbps	72Mbps
Outgoing Bandwidth	64Mbps	64 Mbps	80Mbps
Remote Users	128		
Protocols	TCP/IP, P2P, UPnP, NTP, DHCP, PPPoE		
Video/Audio Output			
CVBS Output	1-ch, BNC	1-ch, BNC	1-ch, BNC
VGA Output	1920x1080p/60Hz, 1920x1080p/50Hz, 1600x1200/60Hz, 1280x1024/60Hz, 1280x720/60Hz, 1024x768/60Hz		
HDMI Output	1920x1080p/60Hz, 1920x1080p/50Hz, 1600x1200/60Hz, 1280x1024/60Hz, 1280x720/60Hz, 1024x768/60Hz	4K(3840X2160)/60Hz , 4K(3840X2160)/30Hz, 1920x1080p/60Hz, 1920x1080p/50Hz, 1600x1200/60Hz, 1280x1024/60Hz, 1280x720/60Hz, 1024x768/60Hz	1920x1080p/60Hz, 1920x1080p/50Hz, 1600x1200/60Hz, 1280x1024/60Hz, 1280x720/60Hz, 1024x768/60Hz
Recording Resolution	8MP Lite/5MP Lite/4MP Lite /3MP/1080P/960P/720P/960H/4CIF/CIF		
Audio Output	1-ch, RCA		
Synchronous Playback	8-ch	8-ch	16-ch
Encoding			
Recording Frame Rate	Main stream: 8MP Lite@8fps(channel1-channel2) 5MPLite@12fps 4MP Lite@15fps 3MP@15fps(channel1 - channel2) 2MP@15fps 720P@30fps Sub stream: D1@30fps(Max)	Main stream: 8MP@8fps 5MP@12fps 4MP@15fps 3MP@18fps 2MP@25fps 720P@30fps Sub stream: D1@30fps(Max)	Main stream: 8MP Lite@8fps (channel1-channel4) 5MP Lite@12fps 4MP Lite@15fps 3MP@15fps(channel1 - channel 4) 2MP@15fps 720P@30fps Sub stream: D1@30fps(Max)
Recording Resolution	8MP Lite/5MP Lite/4MP Lite /3MP/1080P/960P/720P/960H/4CIF/CIF	8MP/5MP/4MP/3MP/1080P/960P/720P/960H/4CIF/CIF	8MP Lite/5MP Lite/4MP Lite /3MP/1080P/960P/720P/960H/4CIF/CIF
Hard Disk			
SATA	2 SATA interface		

Capacity	up to 6TB for each HDD		
External Interface			
Network Interface	1RJ45 10M/100M self-adaptive Ethernet Interface	1RJ45 10M/100M/1000M self-adaptive Ethernet Interface	
USB Interface	Rear panel: 1 x USB2.0,Front panel: 1xUSB2.0	Rear panel: 1 x USB3.0,Front panel: 1xUSB2.0	
Serial Interface	1 x RS485		
Alarm In	-	8	-
Alarm Out	-	4	-
General			
Power Supply	12V DC Power Consumption: ≤ 8 W(without HDD)	12V DC Power Consumption: ≤ 12 W(without HDD)	
Working Environment	-10°C~+ 55°C (+14°F~+131°F), Humidity ≤ 90% RH (non-condensing)		
Dimensions(W×D×H)	380mm ×315mm× 53mm (15" × 12.4"×2.1")		
Weight (without HDD)	≤1.9 Kg (4.19lb)		

Dimensions

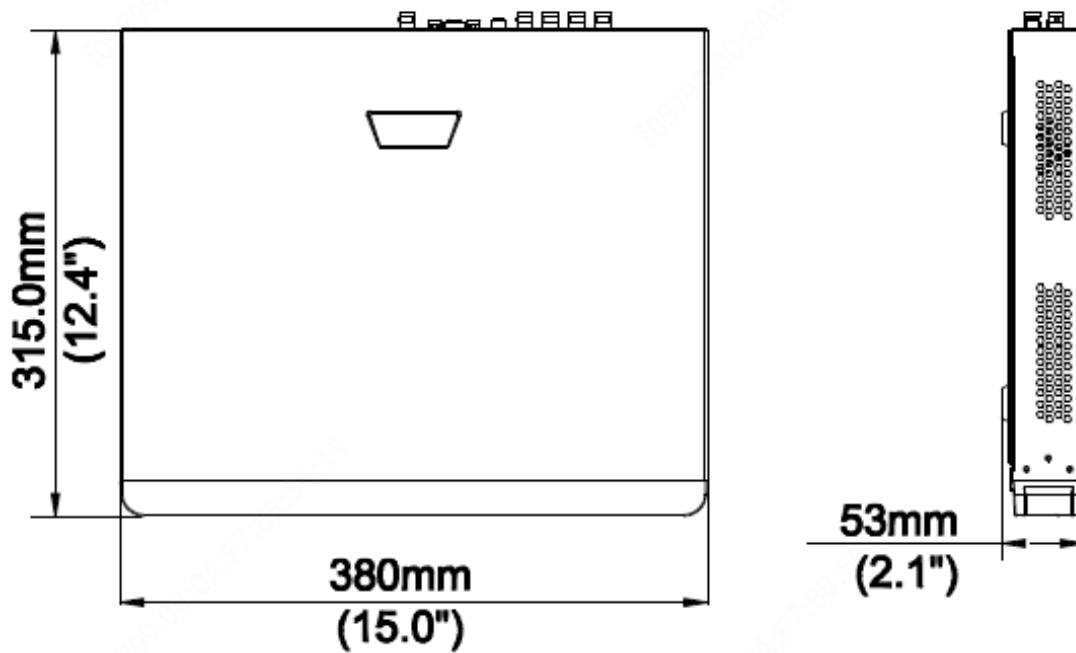

Rear Panel

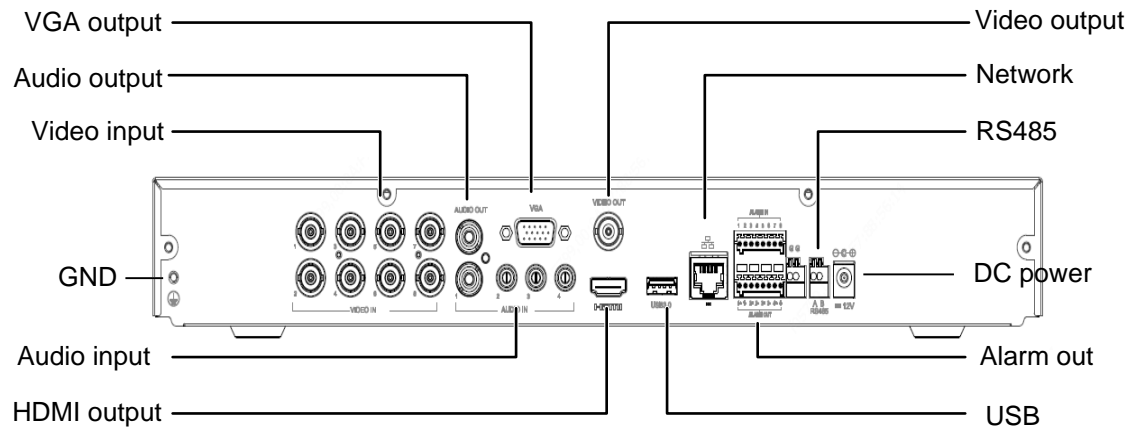

Zhejiang Uniview Technologies Co., Ltd.

Building No.10, Wanlun Science Park, Jiangling Road 88, Binjiang District, Hangzhou, Zhejiang, China

Email: overseasbusiness@uniview.com; globalsupport@uniview.com

<http://www.uniview.com>

©2011-2019 Zhejiang Uniview Technologies Co., Ltd. All rights reserved.

* Product specifications and availability are subject to change without notice.